

## SLIDE BOXES

Slide boxes consist of several pieces of liners and sleeves sliding in different directions into each other.

This group also includes outside sleeves for other cases.

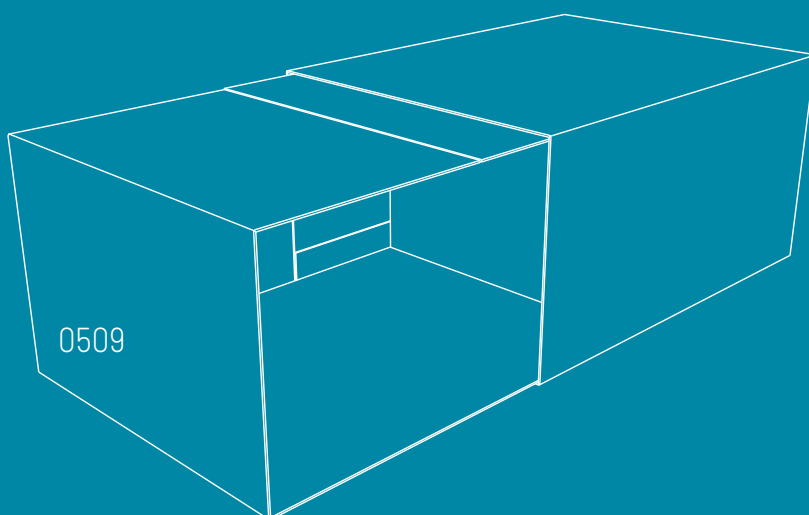
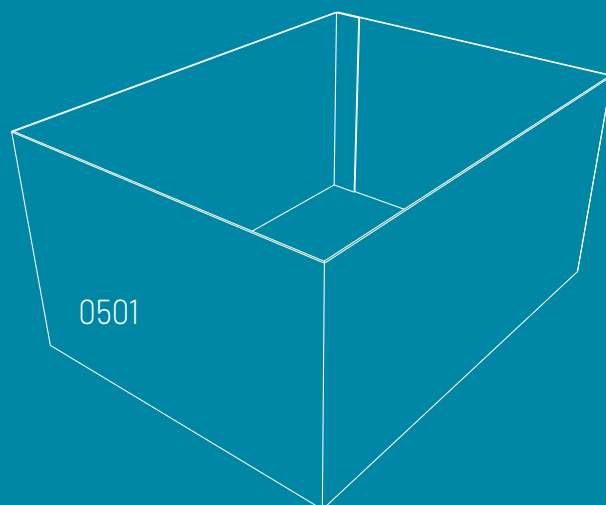
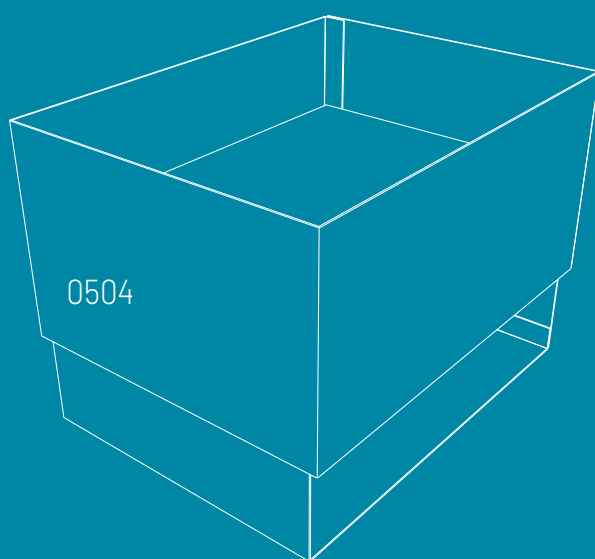

0501 M

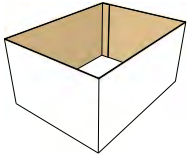

0502 M

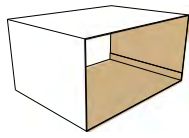

0503 M

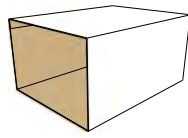

0504 M

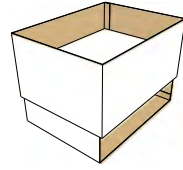

0505 M

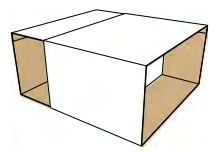

0507 M

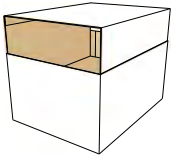

0509 M

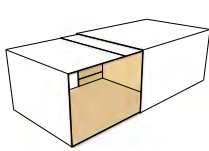

0510 M

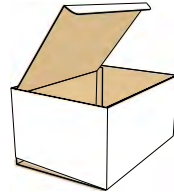

0511 M

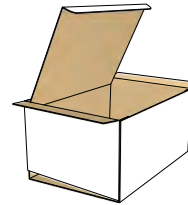

0512 M

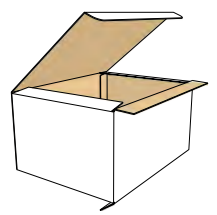

## 0501 M

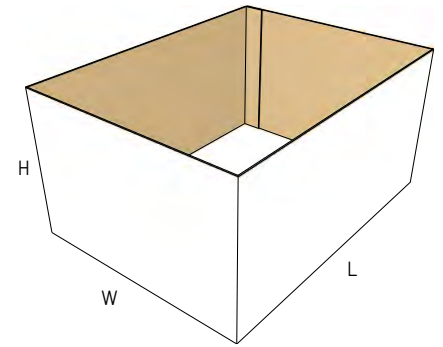

## 0502 M

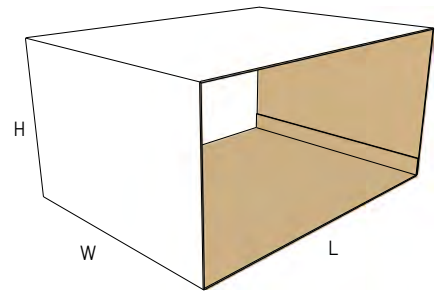
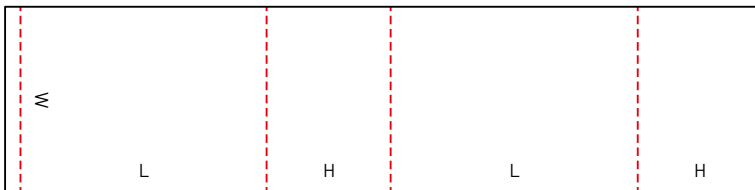

## 0503 M

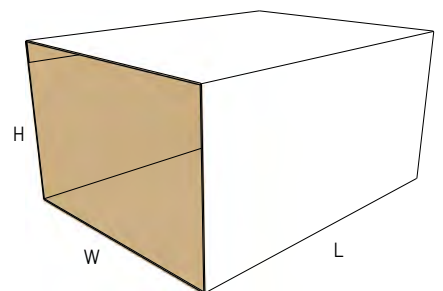
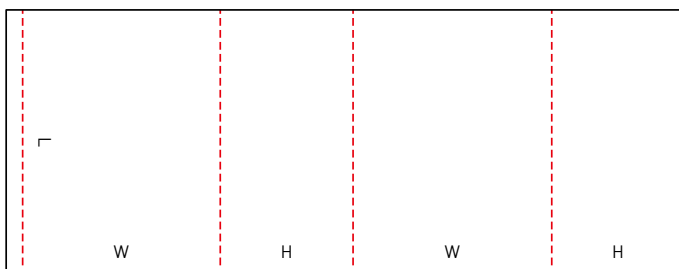

## 0504 M

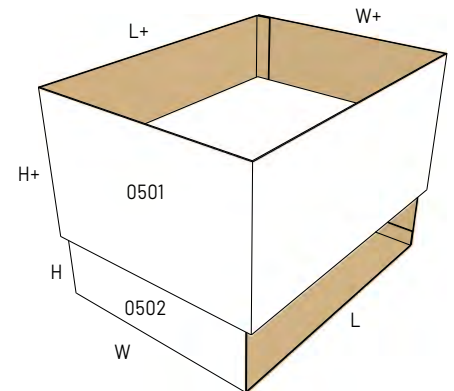
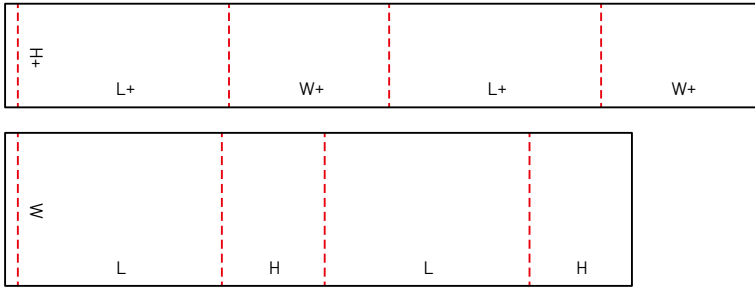

## 0505 M

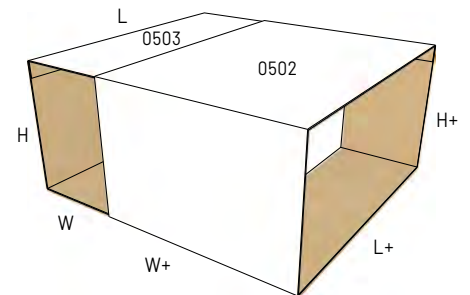
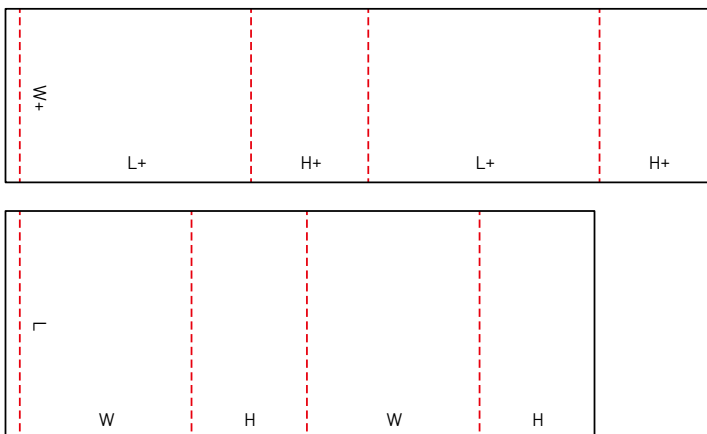

## 0507 M

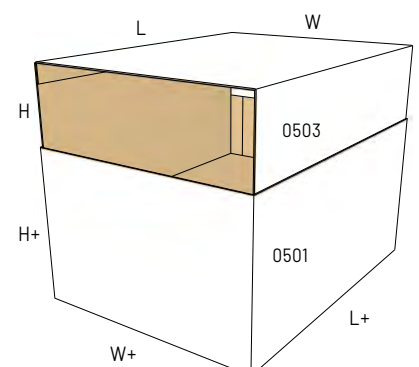
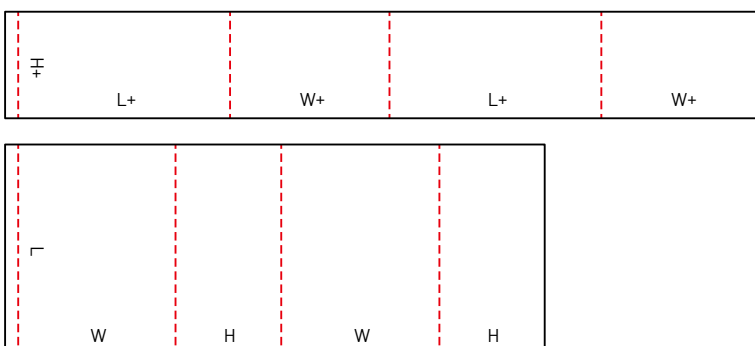

## 0509 M

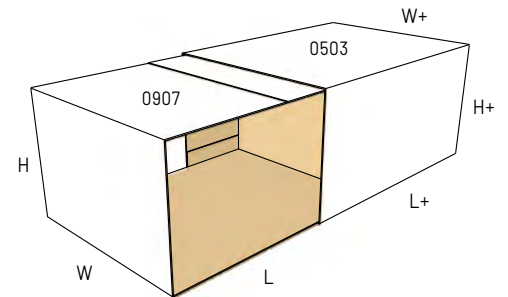
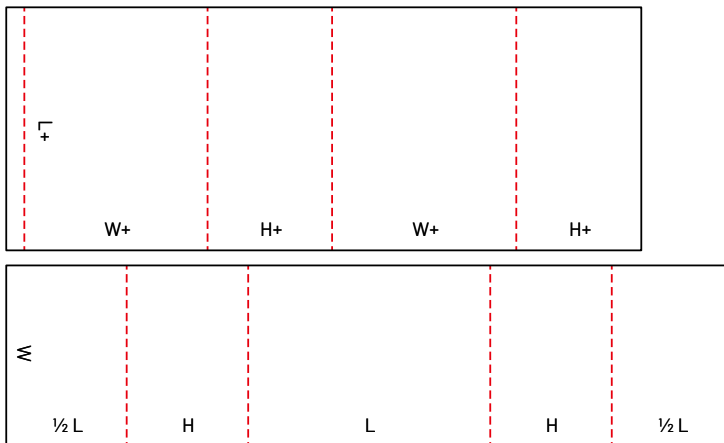

## 0510 M

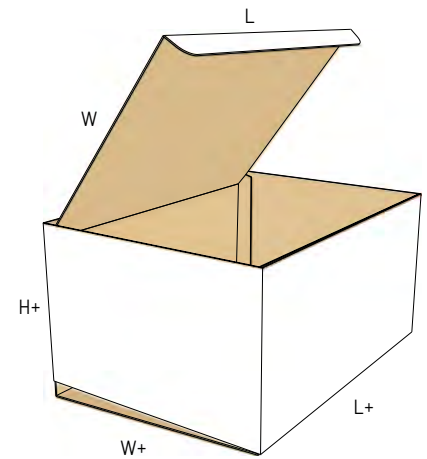
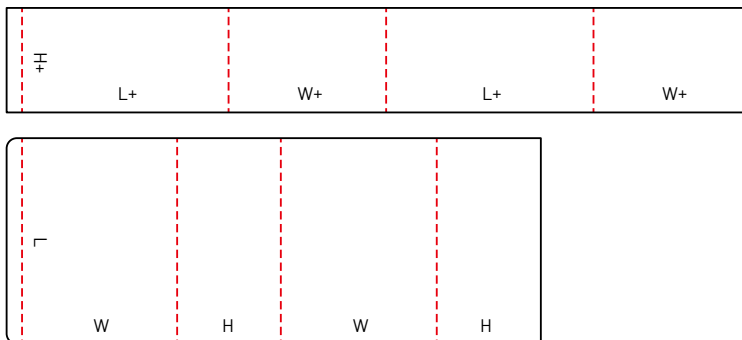

## 0511 M

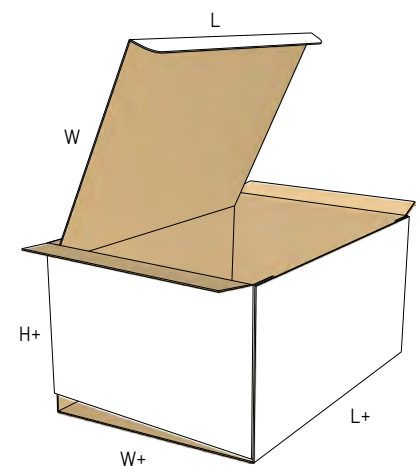
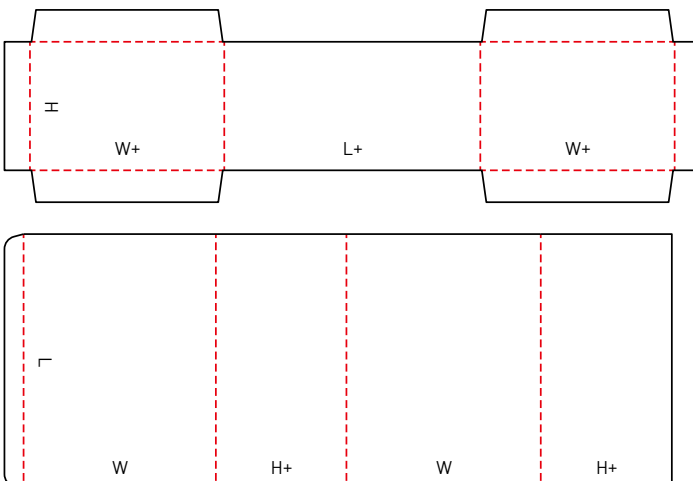

## 0512 M

